

PESC40120Y-R

Silicon Carbide 1200V Schottky Diode



重庆平伟半导体股份有限公司

Features

- Revolutionary semiconductor material - Silicon Carbide
- Benchmark switching behavior
- No reverse recovery/ No forward recovery
- Temperature independent switching behavior
- Optimized for high temperature operation
- Qualified according to JEDEC criteria

TO-247-2L

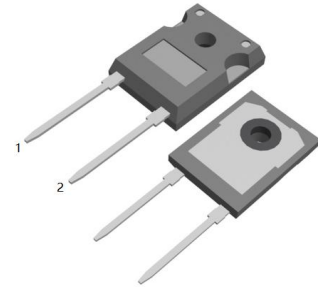

Applications

- Switch mode power supply
- Power factor correction
- Solar inverter
- Uninterruptible power supply

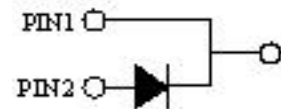

Description

- System efficiency improvement over Si diodes
- Enabling higher frequency / increased power density solutions
- System size/cost savings due to reduced heatsink requirements and smaller magnetics
- Reduced EMI
- Highest efficiency across the entire load range
- Robust diode operation during surge events
- High reliability



Key performance parameters

Product Summary

V_{DC}	1200V
I_F	40A
$T_{j,max}$	175°C

Package Marking and Ordering Information

Part #	Marking	Package	Packing	Reel Size	Tape Width	Qty
PESC40120Y-R	PESC40120Y	TO-247-2L	Tube	N/A	N/A	30pcs

PESC40120Y-R

Silicon Carbide 1200V Schottky Diode



重庆平伟半导体股份有限公司

Absolute Maximum Ratings

Parameter	Symbol	Value	Unit
Repetitive peak reverse voltage	V_{RRM}	1200	V
Continuous forward current for $T_C = 150^\circ\text{C}$	I_F	40	A
Non-Repetitive Peak Forward Surge Current $T_C=25^\circ\text{C}, t_p=8.3\text{ ms}$, Half Sine Pulse $T_C=150^\circ\text{C}, t_p=8.3\text{ ms}$, Half Sine Pulse	I_{FSM}	330 310	A
i^2t value $T_C = 25^\circ\text{C}$, $t_p=8.3\text{ ms}$ i^2t value $T_C = 150^\circ\text{C}$, $t_p=8.3\text{ ms}$	$\int i^2 dt$	452 399	A^2s
Total power dissipation $T_C = 25^\circ\text{C}$	P_D	278	W
Operating junction and storage temperature	T_j, T_{stg}	-55 to +175	$^\circ\text{C}$
Soldering temperature, wave soldering only allowed at leads (1.6mm from case for 10s)	T_{sld}	260	$^\circ\text{C}$

Thermal Resistance

Parameter	Symbol	Condition	Value			Unit
			min.	typ.	max.	
Thermal resistance, junction - case.	R_{thJC}		-	0.43	0.5	°C/W
Thermal resistance, junction - ambient(min. footprint)	R_{thJA}		-		50	°C/W

Electrical Characteristic

Static Characteristic ($T_j=25^\circ\text{C}$ unless otherwise noted)

Parameter	Symbol	Test Condition	Value			Unit
			min.	typ.	max.	
DC blocking voltage	V_{DC}	$I_R=100\mu\text{A}$	1200	-	-	V
Forward voltage	V_F	$I_F=40\text{A}, T_j=25^\circ\text{C}$	-	1.35	1.65	V
		$I_F=40\text{A}, T_j=150^\circ\text{C}$	-	1.62	1.90	V
Reverse current	I_R	$V_R=1200\text{V}, T_j=25^\circ\text{C}$		5	10	μA
		$V_R=1200\text{V}, T_j=150^\circ\text{C}$	-	20	100	

Dynamic Characteristic ($T_j=25^\circ\text{C}$ unless otherwise noted)

Parameter	Symbol	Test Condition	Value			Unit
			min.	typ.	max.	
Total capacitance	C	$V_R=0.1\text{V}, f=1\text{MHz}$	-	5351	-	pF
		$V_R=400\text{V}, f=1\text{MHz}$	-	189	-	
		$V_R=800\text{V}, f=1\text{MHz}$	-	135	-	
Total capacitive charge	Q_C	$V_R=800\text{V}, Q_c = \int_0^{V_R} C(V)dV$	-	232	-	nC



Typical Performance Characteristics

Fig 1: Forward Characteristics

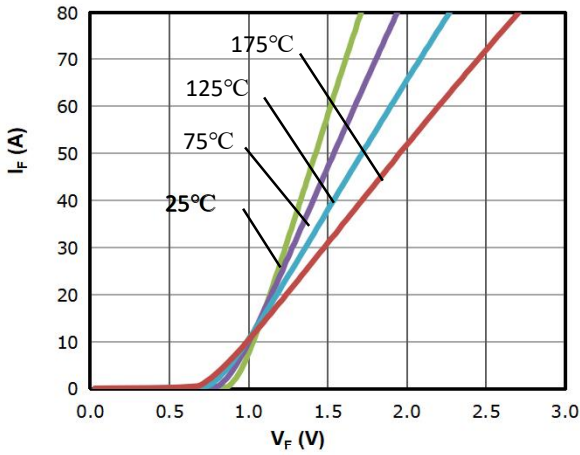

Fig 2: Reverse Characteristics

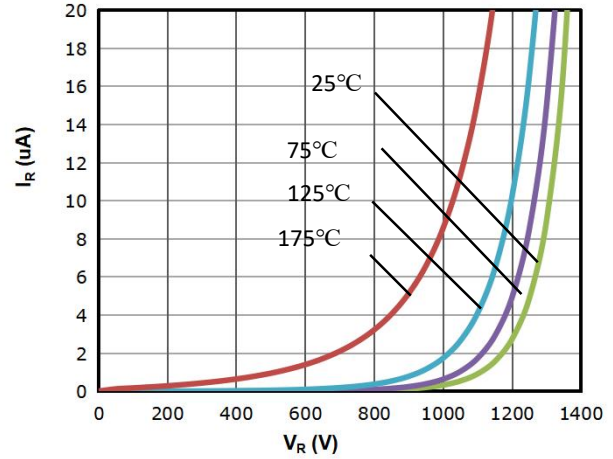

Fig 3: Total Capacitance Charge VS. Reverse Voltage

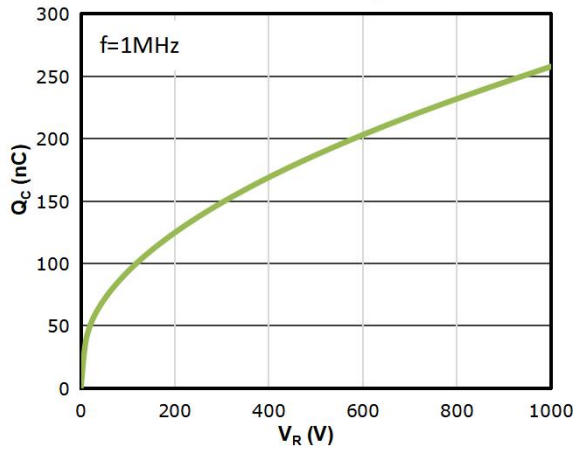

Fig 4: Capacitance Characteristics

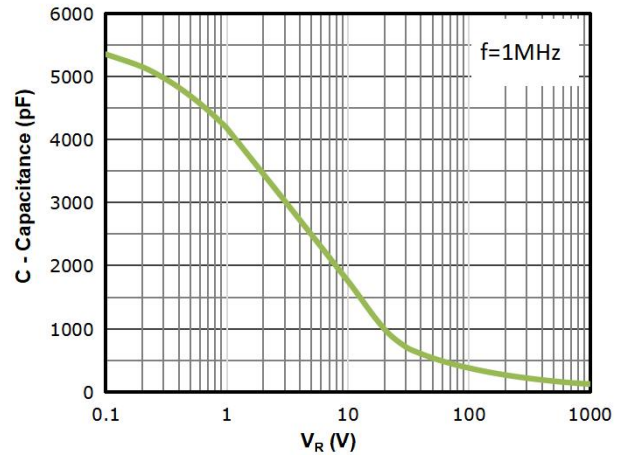

Fig 5: Power Dissipation

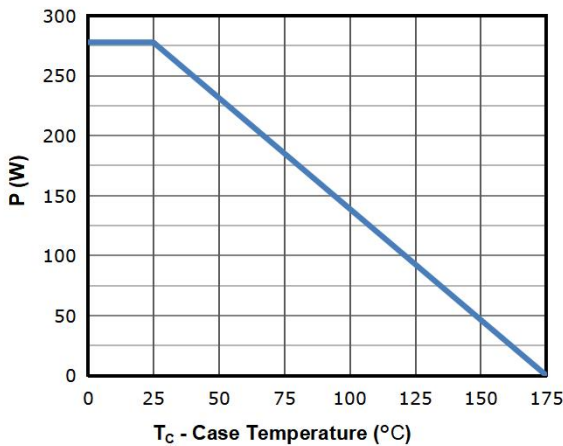
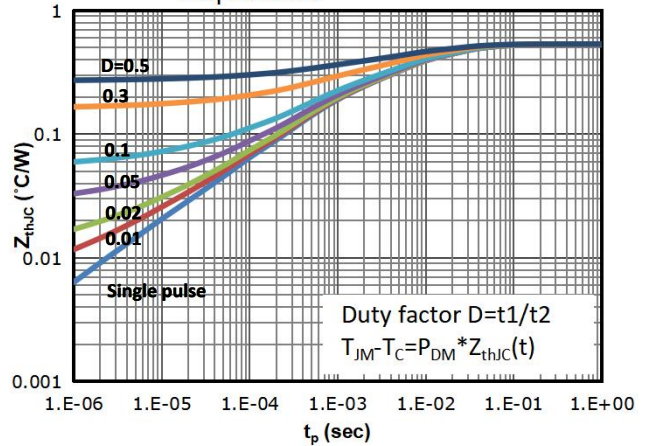

Fig 6: Max. Transient Thermal Impedance



PESC40120Y-R

Silicon Carbide 1200V Schottky Diode



重庆平伟半导体股份有限公司

Package Outline: TO-247-2L

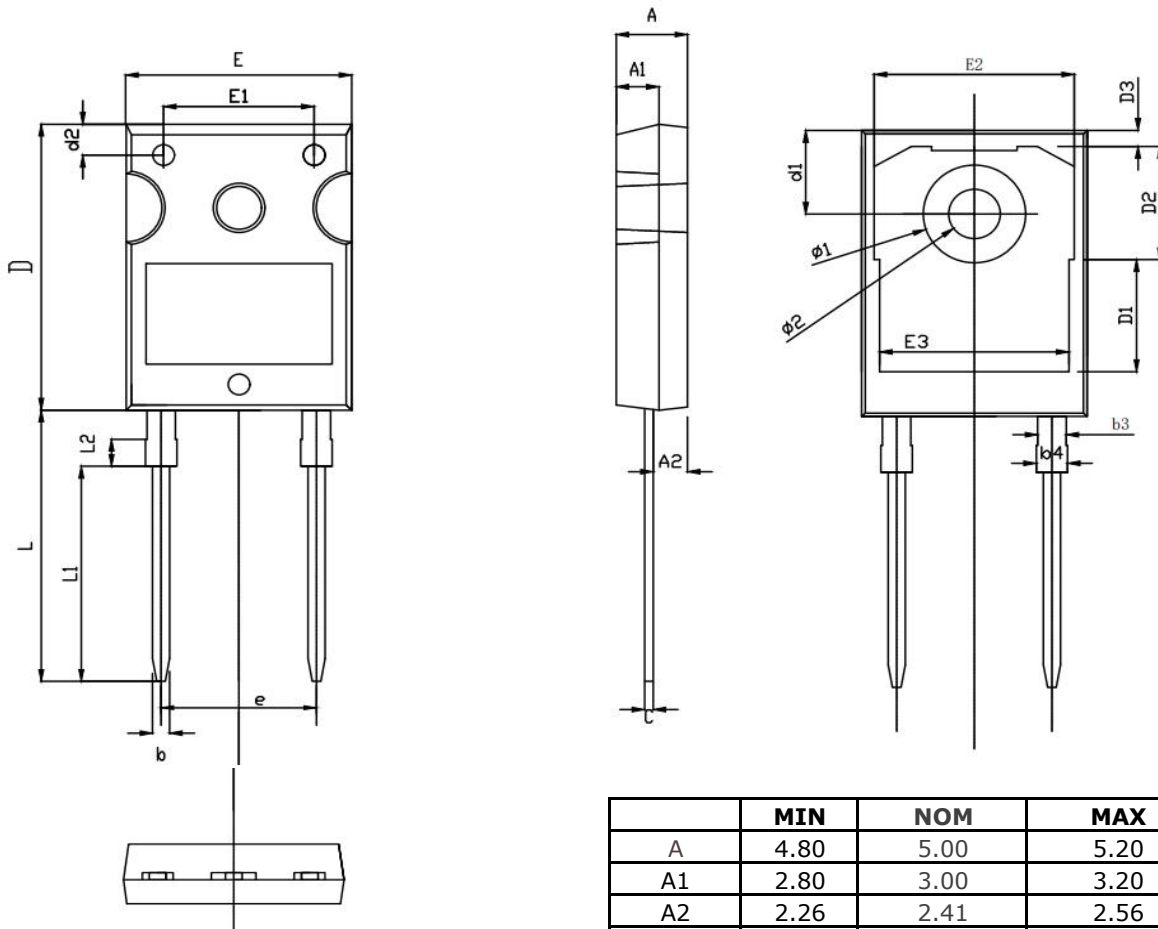

RECOMMENDED LAND PATTERN

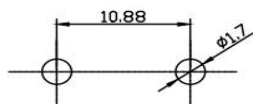

UNIT: mm

	MIN	NOM	MAX
A	4.80	5.00	5.20
A1	2.80	3.00	3.20
A2	2.26	2.41	2.56
b	1.10	1.20	1.30
b3	1.90	2.00	2.10
b4	2.00	-	2.20
C	0.50	0.60	0.70
D	20.80	21.00	21.20
D1	8.03	8.23	8.43
D2	8.12	8.32	8.52
D3	0.97	1.17	1.37
d1	6.00	6.15	6.30
d2	2.20	2.30	2.40
E	15.60	15.80	16.00
E1	10.30	10.50	10.70
E2	13.82	14.02	14.22
E3	13.30	13.50	13.70
e	10.68	10.88	11.08
L	19.72	19.92	20.12
L1	15.59	15.79	15.99
L2	1.78	1.98	2.18
Ø1	7.10	7.19	7.30
Ø2	3.50	3.60	3.70



Disclaimer

Any and all semiconductor products have certain probability to fail or malfunction, which may result in personal injury, death or property damage. Customer are solely responsible for providing adequate safe measures when design their systems.

Unless otherwise specified in the datasheet, the product is designed and qualified as a standard commercial product and is not intended for use in applications that require extraordinary levels of quality and reliability, such as automotive, aviation/aerospace and life-support devices or systems.

Buyer is responsible for its products and applications using PingWei products, including compliance with all laws, regulations and safety requirements or standards, regardless of any support or applications information provided by PingWei.

"Typical" parameters which may be provided in PingWei data sheets and/or specifications can and do vary in different applications and actual performance may vary over time. All operating parameters, including "Typicals" must be validated for each customer application by customer's technical experts

ALL PRODUCT, PRODUCT SPECIFICATIONS AND DATA ARE SUBJECT TO CHANGE WITHOUT NOTICE TO IMPROVE RELIABILITY, FUNCTION OR DESIGN OR OTHERWISE